



## Unidrive M700



**Class leading performance  
with onboard real-time Ethernet**

0.75 kW - 2.8 MW Heavy Duty (1.0 hp - 4,200 hp)  
200 V | 400 V | 575 V | 690 V



**CONTROL TECHNIQUES™**

**Nidec**  
All for dreams

# Unidrive M

## Optimized throughput, open automation systems, maximum ease of use

Led by the results of extensive customer-driven market research, we have tailored five Unidrive M feature-sets to specific application needs identified within Industrial Automation. The Unidrive M700 provides class-leading motor control for induction, permanent magnet and servo applications, plus onboard real-time Ethernet. Unidrive M700 offers an enhanced upgrade for existing Unidrive SP users.



# Unidrive M700 features

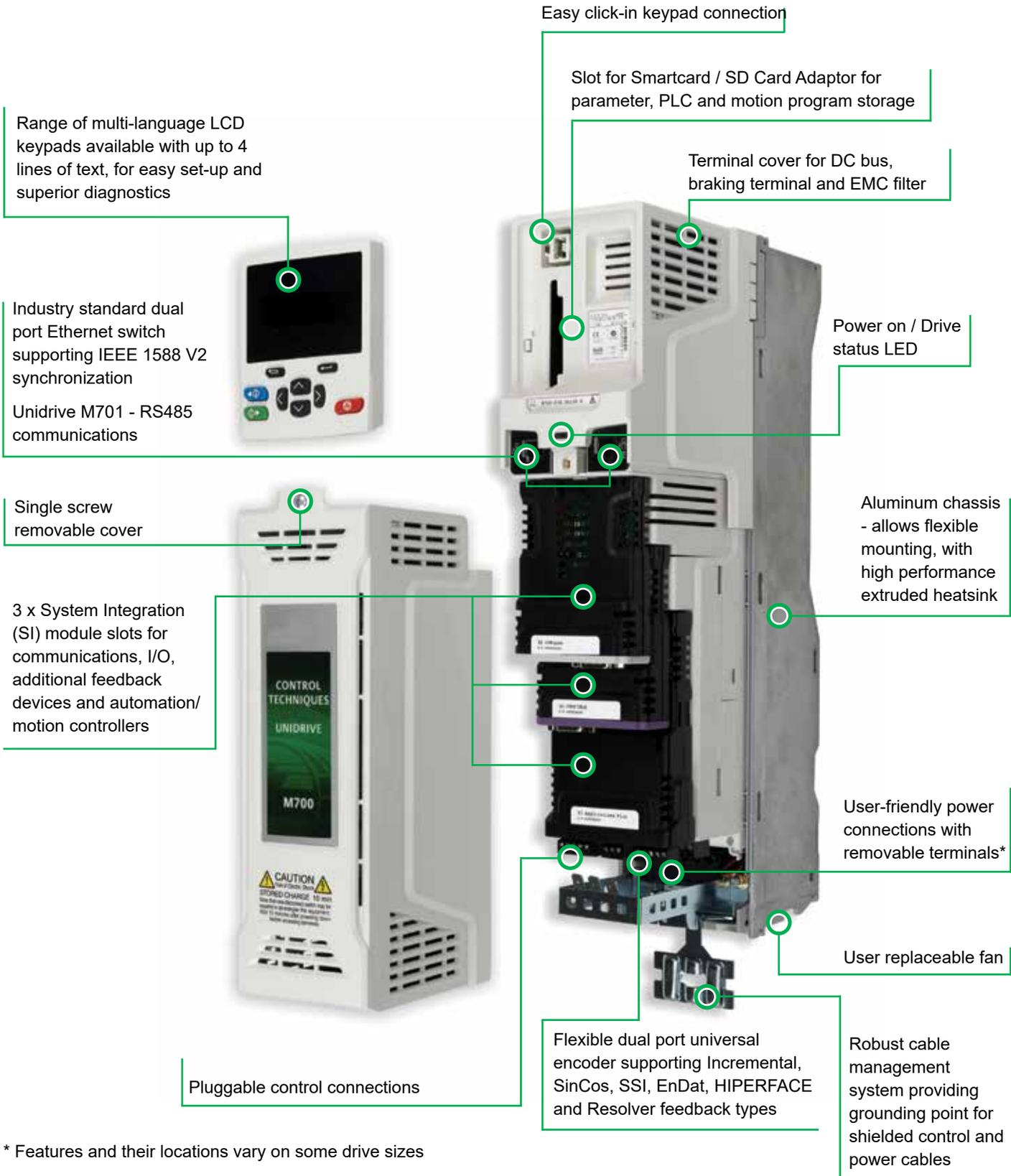

\* Features and their locations vary on some drive sizes

# Unidrive M700

## Class leading induction, permanent magnet and servo motor performance with onboard real-time Ethernet

Unidrive M700 provides high performance motor control and ultimate control flexibility in order to satisfy the requirements of machine builders and high specification industrial and hoisting applications. M700 offers an enhanced upgrade for existing Unidrive SP users.

### Unidrive M700 benefits:

#### Maximize throughput with superior motor control

- High bandwidth motor control algorithm for closed loop induction, permanent magnet and servo motors - 3,000 Hz current loop bandwidth and 250 Hz speed loop bandwidth
- Flexible speed and position feedback interface supports a wide range of feedback technologies from robust resolvers to high resolution encoders
  - Up to three encoder channels simultaneously e.g. 1 feedback encoder, 1 reference encoder and 1 simulated output
  - Quadrature, SinCos (including absolute), SSI, EnDat (up to 4 Mb with EnDat 2.2 and 100 m of cable as line compensation is supported) and resolvers
  - Simulated encoder output can provide position reference for CAMs, digital lock and electronic gearbox applications

#### Optimize system performance with onboard Advanced Motion Controller

- M700 incorporates an Advanced Motion Controller capable of controlling 1.5 axes. The motion functions are carried out 'on the drive' so that system performance is maximized

#### Design flexible centralized and decentralized control systems

- Onboard PLC for logic programs
- MCI modules can be added to execute larger programs for advanced system control capability
- Machine Control Studio is an industry standard IEC61131-3 programming environment for efficient system design and configuration
- Integrated dual port Ethernet switch provides simple connectivity using standard connections
- Onboard real-time Ethernet (IEEE 1588 V2) uses RTMoE (Real-Time Motion over Ethernet) to provide fast communication and accurate axis synchronization
- Three System Integration (SI) ports are available to fit additional fieldbus, position feedback and I/O options



**Conform to safety standards, maximize uptime and reduce costs by integrating directly with safety systems**

- M700 has an integrated Safe Torque Off (STO) input and can accommodate an SI-Safety module for safe motion functions

**Powerful and easy field service and upgrade**

The M700 is designed to quickly and easily extend the field service life of previous generations of products. M701 provides a direct upgrade path from Unidrive SP.

- Unidrive M700 and M701 can import Unidrive SP settings using a Smartcard
- Unidrive M700 and M701 have the same terminal layout as Unidrive SP
- SI-Applications Plus modules allows Unidrive SP SyPTPro programs to be recompiled for Unidrive M700
- Unidrive M700 is more compact than Unidrive SP. Fixing points for existing Unidrive SP installations can be used with standard mounting brackets or conversion kits

To maximize customer choice, the M700 offers the following 3 variants:

**M700 - Ethernet**

Onboard real-time Ethernet is included on the standard M700, with 1 x Safe Torque Off (STO) and both analog and digital I/O, making it an incredibly versatile high performance AC drive.

**M701 - Unidrive SP replacement**

Designed to match Control Techniques' highly popular Unidrive SP feature-set. This includes RS485 communications, 1 x STO, analog and digital I/O, identical control connectors, with Unidrive SP Smartcard parameter sets supported to make upgrading to Unidrive M as simple as possible.

**M702 - Safety Enhanced**

The safety enhanced M702 has 2 x STO, onboard real-time Ethernet and digital I/O, where easy integration with modern control and safety systems is paramount. If analog I/O is required, this can be provided by an SI-I/O option module.

## Performance control for every motor

Control Techniques' unique motor control algorithms combined with the latest microprocessor technology ensure that Unidrive M drives offer the highest stability and bandwidth for all industrial motor types. This enables maximum machine throughput in every application and with every motor, from standard AC induction motors to dynamic linear motors and from energy saving permanent magnet motors to high performance servo motors.

- High bandwidth motor control algorithm for open and closed loop induction and PM servo motors with up to 3,000 Hz current loop bandwidth and 250 Hz speed loop bandwidth

## Matched servo motors for maximum performance

Nidec offers two ranges of AC brushless servo motors to match diverse application needs.

### Unimotor fm

Flexible performance AC brushless servo motor  
0.72 Nm -136 Nm (408 Nm peak) | 6.37 lb-in - 1,203 lb-in  
(3,611 lb-in peak)

Unimotor fm is a flexible performance AC brushless servo motor range optimized for use with Unidrive M. The motors are available in six frame sizes with various mounting arrangements, motor lengths and a wide range of feedback options.

### Unimotor hd

Compact servo motor for demanding applications  
0.72 Nm - 85.0 Nm (255 Nm peak) | 6.37 lb-in - 752 lb-in  
(2,256 lb-in peak)

Unimotor hd is a high dynamic servo motor range, designed for maximum torque density. This AC brushless servo motor range provides an exceptionally compact, low inertia solution for applications where rapid acceleration and deceleration is required.

### Electronic nameplates

- All Unimotor servo motors with communication based encoders come with electronic nameplate data preloaded. Unidrive M uses this data directly for faster and more accurate motor matching and commissioning.





## Matched drives and motors maximize performance and energy efficiency

Unidrive M is designed to enhance the energy efficiency of all applications:

- Low power standby mode. In some applications, drives can sit idle for significant periods; Unidrive M's reduced standby power saves energy
- Easy common DC bus configuration enables braking energy to be recycled within the drive system, reducing energy usage and eliminating external supply components

- Unidrive M supports sensorless (open loop) control of compact high efficiency permanent magnet motors
- Active Front End for regenerative AC drive systems
- Dyneo®: perfectly synergized permanent magnet motor and Unidrive M solutions - optimized for performance and energy saving
- Nidec's Dyneo® Unidrive M and permanent magnet motor solutions offer exceptional efficiency levels across all operating speeds, especially at lower speeds where the efficiency is much higher than induction motors
- Low losses, up to 98% efficient

### Motor control options available include:

Control Mode	Features
<b>Open</b> loop vector or V/Hz induction motor control	Open loop motor control for induction motors and the easiest configuration. V/Hz can be used for multiple motor control.
<b>Open</b> loop Rotor Flux Control for induction motors (RFC-A)	Vector algorithm utilizing closed loop current control to greatly enhance performance for all induction motor sizes.
<b>Open</b> loop permanent magnet motor control (RFC-S)	Open loop control of compact, high efficiency, permanent magnet motors (including the Leroy-Somer Dyneo® LSRPM).
<b>Closed</b> loop Rotor Flux Control for induction motors (RFC-A)	Speed and position control for induction motors, supporting a wide range of feedback devices.
<b>Closed</b> loop control of permanent magnet and servo motors (RFC-S)	Dynamic control of high efficiency and servo permanent magnet motors supporting a wide range of feedback devices.
<b>Active</b> Front End for power quality and regeneration	Active Front End allows regeneration of energy back onto the power line. The Active Front End also provides power factor control for power quality management and greatly reduces unwanted power harmonics.

# Machine controllers: MCI200, MCI210 and SI-Applications Plus

## Second processor for PLC programs and multi-axis control

MCI modules add a powerful processor to Unidrive M700 which can execute comprehensive application programs to extend system and machine control capability. As a result of the highly flexible plug-in option module format, system design is streamlined by removing the need for PLCs and other external components. Programs are fast and easy to develop thanks to the user-friendly Machine Control Studio software which uses industry standard IEC 61131-3 programming languages to build highly flexible and productive systems. MCI programs can access and manage Unidrive M's embedded Advanced Motion Controller across a wide range of networks to provide perfectly synchronized multi-axis machine performance and throughput.

## Save costs and streamline machine design

- MCI modules can eliminate the need for external PLCs and motion controllers
- Plug-in option modules powered from the drive's internal power supply mean less wiring and less physical space is required
- Simple integration with external components such as I/O, HMIs and other networked drives can be achieved using Unidrive M's integrated standard Ethernet ports (with RTMoE or standard protocols), or fieldbuses supported by SI option modules (EtherCAT, PROFINET, PROFIBUS, CANopen)
- MCI210 has two additional Ethernet ports with an internal switch



## Segregated network control

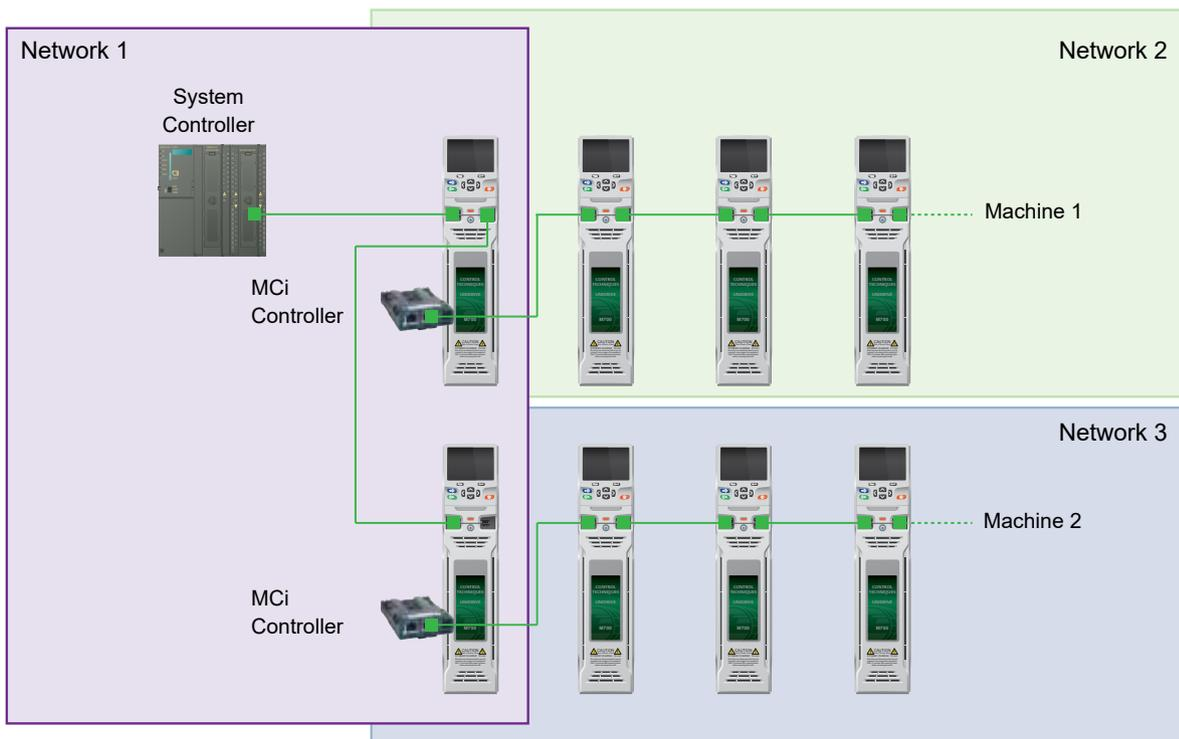

## Build high performance systems and productive machines

- MCI modules execute comprehensive programs that can control multiple drives and motors simultaneously across real-time networks
- M700's onboard Ethernet using RTMoE (Real-Time Motion over Ethernet) provides synchronization and communication between drives using the Precision Time Protocol as defined by IEEE1588 V2
- Performance is optimized by having a motion controller embedded in each networked drive
- MCI210 ensures higher performance by delivering:
  - Two additional Ethernet ports with an internal switch
  - Support for standard Ethernet protocols, along with RTMoE for PTP (IEEE 1588) synchronization
  - Modbus TCP/IP master (up to 5 nodes)
  - Parallel interface with drive processor provides faster data exchange
  - Machine control over two segregated Ethernet networks enables greater flexibility in machine design
  - Extends connectivity with 3 x digital inputs, 1 x digital output and 1 x digital I/O

## SI Applications Plus

SI-Applications Plus modules allow SyPTPro application programs to be recompiled and executed with Unidrive M700 to enable rapid and simple upgrade for Unidrive SP users. Applications comprising networked Unidrive SP drives with SM-Applications using CNet or CTSync for real-time control can be quickly replaced with Unidrive M and the SI-Applications Plus module without any compromise to system performance.

- EIA-RS485 port supports ANSI, Modbus-RTU master and follower and Modbus-ASCII master and follower protocols
- CNet high speed network connection offering up to 5 Mbit/s data rate
- Two 24 V digital inputs and two outputs
- CTSync connection can distribute a master position to multiple drives on a network. Hardware synchronization of speed, position and torque loops

## Unidrive M - flexible communications

System Integration (SI) option modules allow additional connectivity with PROFINET, EtherCAT, PROFIBUS, DeviceNet, CANopen and I/O. Plus connectivity to legacy CNet system

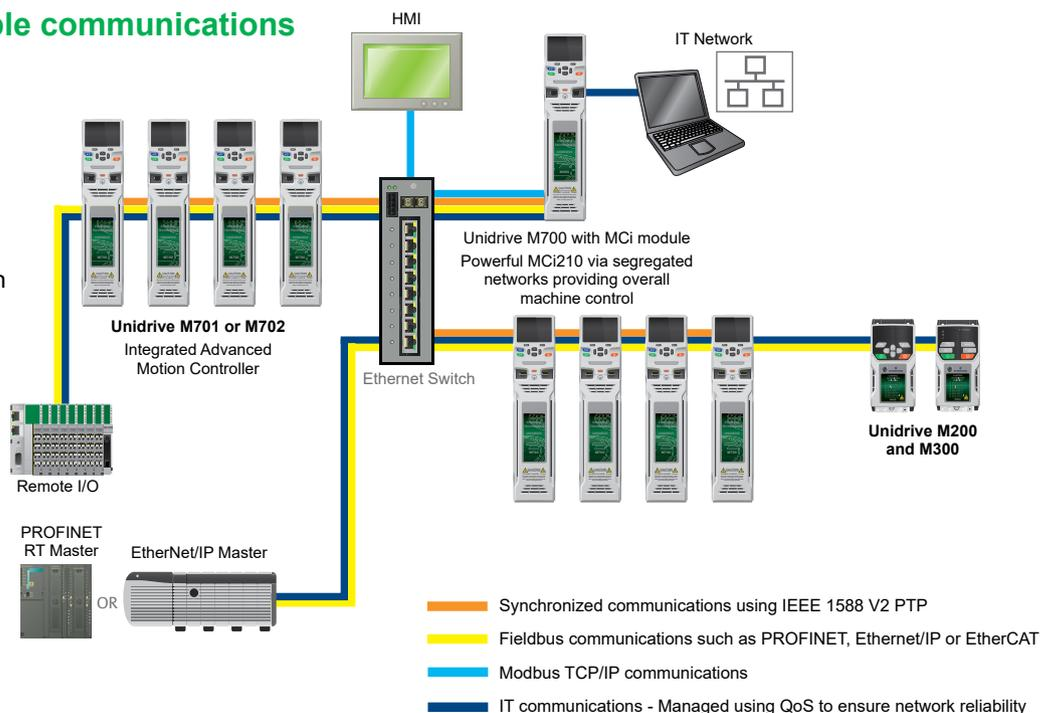

# Open technology, exceptional performance

## Open automation systems

Openness is at the heart of Unidrive M. Unidrive M700 supports a wide range of industry standard technologies and protocols including:

- Open programming languages using IEC 61131-3
- Open fieldbuses and networks including EtherNet/IP, EtherCAT, PROFINET and PROFIBUS
- Ethernet protocols, including PTP protocol for clock synchronization to IEEE 1588 V2

This open approach provides significant benefits to machine builders and OEMs:

- Optimized system **performance** with access to the latest industry technologies, programming languages and communication protocols
- **Future proofing** is assured with the adherence to open standards which ensures continuous compatibility with the latest technologies (such as evolving protocols) and avoids the lock-in risk associated with proprietary products

- System development **speed** is maximized due to use of familiar industrial programming languages and compatibility with standard components
- Large **choice** of compatible 'best-in-class' components provided by the flexibility of open automation
- **Innovation** and **talent** recruitment optimized through broad industry knowledge of open technologies

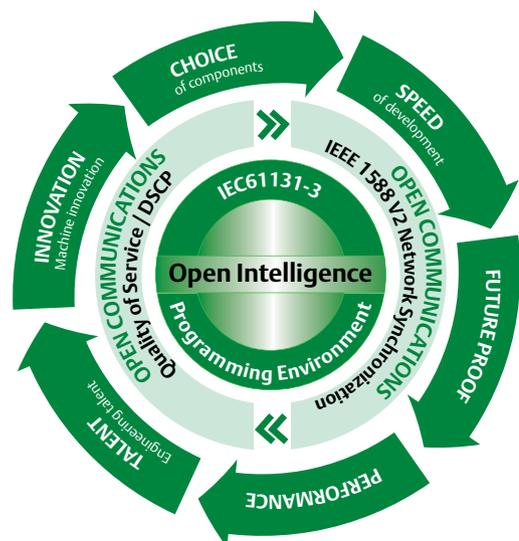

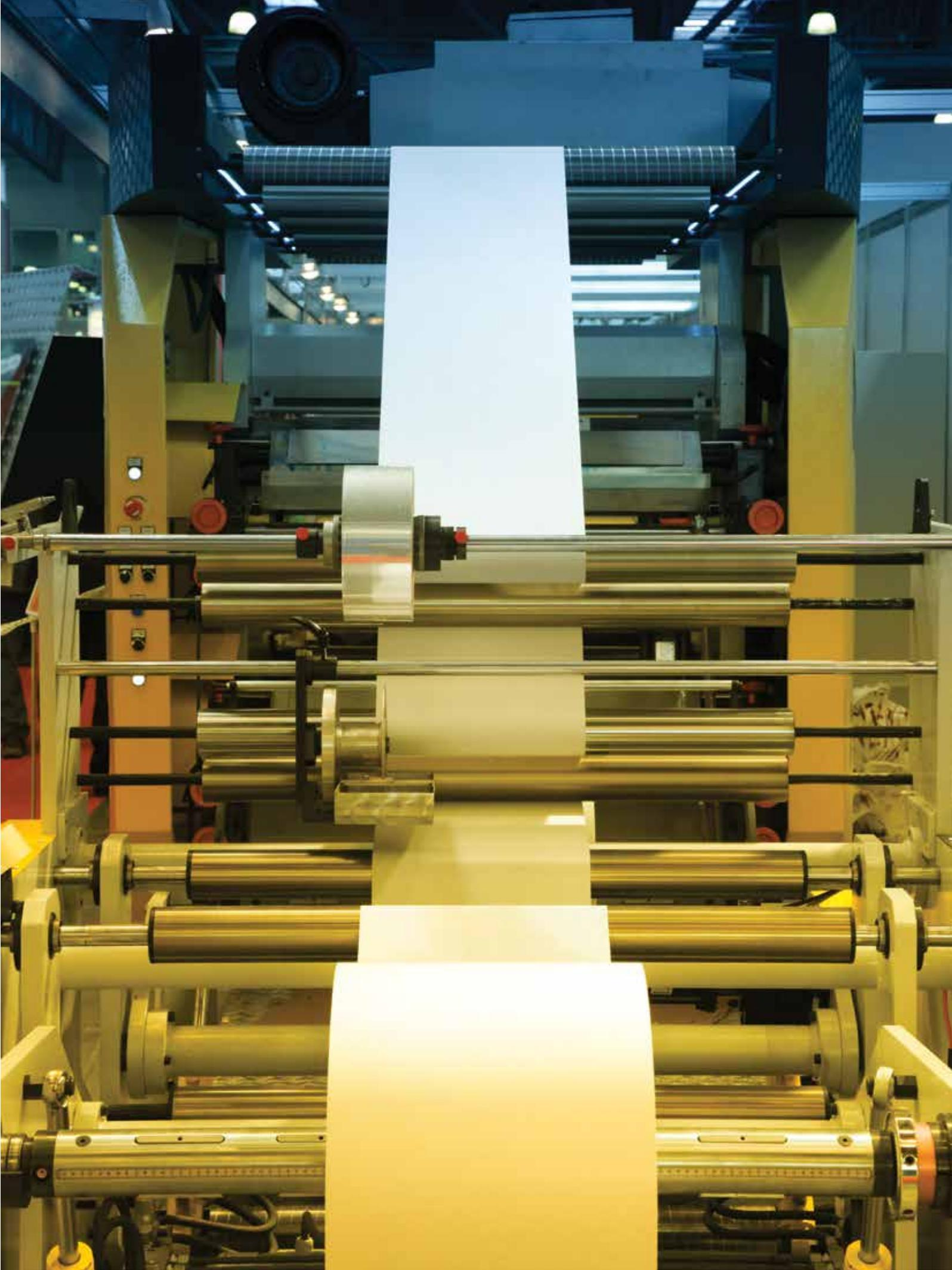

# Machine Control Studio software

Machine Control Studio, built using an IEC61131-3 programming environment, provides a flexible and intuitive environment for programming Unidrive M's automation and motion control features. The software provides programming for:

- M700's onboard PLC
- M700 fitted with MCI200 or MCI210 integrated machine control modules
- Ethernet network data configurations

## IEC 61131-3 motion and automation programming

The programming environment is fully IEC 61131-3 compliant and therefore familiar, fast and easy to use for control engineers around the world.

The following IEC 61131-3 programming languages are supported:

- Structured Text (ST)
- Function Block Diagram (FBD)
- Structured Function Chart (SFC)
- Ladder Diagram (LD)
- Instruction List (IL)

Also supported:

- Continuous Function Chart (CFC)

Intuitive IntelliSense functionality helps to write consistent and robust programs, speeding up software development. Programmers have access to a vibrant open-source community for function blocks. Machine Control Studio also supports customers' own function block libraries, with online monitoring of program variables with user defined watch windows and help for online change of program, in line with latest PLC practice.

Features	Unidrive M onboard	MCI module
Breakpoints	No	Yes
Source code upload/download	No	Yes
Online change	No	Yes
Trigonometric functions	No	Yes
64 bit data types	No	Yes
Real-time task(s)	Yes (min 4ms)	Yes (min 250 $\mu$ s)
Customizable drive menu	Yes (menu 30)	Yes (Menu 27, 28, 29)
Variable tracing	No	Yes
Tasks available	1 x Freewheeling task, 1 x Clock task	1 x Freewheeling task, 1 x Position task, 1 x Initial task, 4 x Clock tasks, 1 x Error task, 4 x Event tasks

## Onboard advanced motion controller

- Advanced 1.5 axes Motion Controller, key features include:
  - Real-time tasks
  - 250  $\mu$ s cycle time
  - Motion profile generator
  - Electronic gearbox
  - Interpolated CAM
  - Homing functions
  - High speed position freeze
- Can be configured straight from the keypad or using Machine Control Studio
- High performance MCI200 and MCI210 control modules for extra control performance

## Open, efficient, synchronized Ethernet

Unidrive M uses standard Ethernet to connect the controller and other devices such as PCs, I/O and HMIs together. Ethernet provides real benefits:

- Maximize machine productivity through high performance deterministic Ethernet, suitable for complete automation and demanding synchronized motion functions
- Access future developments in IT based industries where billions of nodes are installed, future proofing your investments
- Access to a wide choice of network monitoring and diagnostics tools
- Flexible network topologies including star and tree for simplicity and networking
- Ethernet web pages are hosted on the M700 drive. This removes the need to purchase specialist software for diagnostics, allowing engineers to connect to the drive from any web-enabled device.

“Engineers can connect to the drive from any web-enabled device”



Through advances in Ethernet technology, standard Ethernet hardware now delivers the highest levels of performance in industrial networking. For communication between drives, PCs, I/Os and other devices, Unidrive M uses open protocols such as TCP/IP and UDP.

## RTMoE

Unidrive M's standard Ethernet also supports RTMoE (Real-Time Motion over Ethernet) which provides synchronized communication between drives using the Precision Time Protocol as defined by IEEE1588 V2:

- Distributed clocks are used to automatically synchronize the position, speed and current loops across all drives
- Network synchronization of less than 1 $\mu$ s jitter (typically <200 ns)
- 1 ms cycle time for synchronous cyclic data
- Master/follower and peer-to-peer communications capabilities
- Bandwidth protection through a network gateway that manages non-real-time Ethernet messages
- Messages are time stamped to enable real-time operation

## Traffic management

Manage non-critical network traffic through a network gateway

Unidrive M integrates a network gateway feature within the drive's dual port switch. This uses standards called Differentiated Services Code Point (DSCP) and Quality of Service (QoS) to protect network bandwidth by eliminating or delaying non-critical messages from outside the control network.



## Control Mode

Open loop vector or V/Hz induction motor control  
Open loop Rotor Flux Control for induction motors (RFC-A)



Closed loop permanent magnet motor control (RFC-S)



Open loop permanent magnet motor control (RFC-S)



Closed loop Rotor Flux Control for induction motors (RFC-A)



Active Front End (AFE)  
power quality converter



## Optional Drive Programming and Operator Interface

Unidrive M Connect



Operator Interface



KI-Keypad



KI-Keypad RTC



Remote Keypad



Remote keypad RTC



Smartcard



SD Card using SD Card Adaptor



KI-485 Adaptor



## Centralized PLC / Motion Control

Motion Controller



PLC



Industrial Computer



## Optional Input/Output

Remote I/O



SI-I/O



4 x Digital I/O  
3 x Analog input (default) / Digital input  
1 x Analog output (default) / Digital input  
2 x Relay

Standard on M700/M701



5 x Analog I/O  
8 x Digital I/O (including 2 x high speed I/O [250 µs])  
1 x Relay output  
1 x STO

M702: includes 2 x STO, while analog I/O is not present



## Applications with PLC or Motion Functionality

### Standard

Easy to use onboard PLC and advanced motion control using an industry standard IEC61131-3 programming environment



SI-Applications Plus compatible module which allows existing SyPTPro application programs to be re-compiled for M700



MCi200  
Advanced machine control using industry standard IEC61131-3 programming languages



MCi210  
Extended advanced machine control using industry standard IEC61131-3 programming languages with simultaneous connectivity to 2 separate Ethernet networks



## Communications

### Standard

Ethernet (IEEE 1588 V2)  
Modbus TCP/IP  
EtherNet/IP  
TCP/IP  
UDP



SI-EtherCAT



SI-PROFIBUS



SI-Ethernet



SI-DeviceNet



SI-CANopen



SI-PROFINET



## Feedback

### Standard

2 x universal encoder input channels  
Support includes EnDat 2.2, HIPERFACE and SSI  
1 x simulated encoder output



SI-Encoder



SI-Universal Encoder



## Safety

SI-Safety



## DC Back-up Power Supply

24 - 1067 Vdc power\*



24 Vdc control



\*Drive voltage rating dependent

# Fast and easy access for commissioning, monitoring and diagnostics

## Fast and easy access for commissioning, monitoring and diagnostics

Unidrive M keypads, memory devices and software tools make it easy to access Unidrive M700's full feature set, allowing users to optimize drive tuning, back-up the configuration set and troubleshoot more quickly.

### User interface options

Unidrive M benefits from a number of optional keypad choices to meet your application needs.

Type		Benefit
KI-Keypad: Removable plain text LCD keypad		Plain text, multi-language LCD keypad for in depth parameter and data descriptions for an enhanced user experience.
KI-Keypad RTC: Removable plain text LCD with real-time clock		All the features of the KI-Keypad, but with battery operated real-time clock. This allows accurate time stamping of events, aiding diagnostics.
Remote Keypad		Remote mountable, plain text, multi-language LCD keypad allows flexible mounting on the outside of a panel and meets IP66 (NEMA 4).
Remote keypad RTC		The keypad is remote mountable, allowing flexible mounting on the outside of a panel (meets IP54/ NEMA 12). Three line plain text, multi-language LCD keypad for rapid set-up and helpful diagnostics. Battery operated real-time clock allows accurate time stamping of events, aiding diagnostics.



## Unidrive M Connect commissioning tool

The Unidrive M Connect PC tool is for commissioning, optimizing and monitoring drive/system performance. Its development draws from extensive user research, using human centered design principles to give the ultimate user experience:

- Task-based drive operations are simplified with intuitive graphical tools in a familiar Windows environment
- Dynamic drive logic diagrams and enhanced searchable listings
- Drive and motor performance can be optimized with minimal specialized drive knowledge
- Tool is scalable to match application requirements
- Supports the import of Unidrive SP parameter files and allows full drive cloning (i.e. parameter sets and application programs)
- Matching Unidrive M to Nidec motors (such as Dyneo®) can be achieved quickly and easily using Unidrive M Connect's motor database
- Multiple communications channels for a more complete overview of the system
- Drive discovery gives the ability to find drives on a network automatically without the user having to specify their addresses

## Unidrive M's portable memory devices

### Smartcard

Smartcards can be used to back-up parameter sets and basic PLC programs, as well as copying them from one drive to another, including from a Unidrive SP:

- Simplified drive maintenance and commissioning
- Quick set-up for sequential build of machines
- Upgrades to be stored on a Smartcard and sent to the customer for installation

### SD card

Standard SD cards can be used for quick and easy parameter and program storage using an adaptor. SD cards provide a huge memory capability allowing a complete system reload if required, and can be easily pre-programmed on a common PC.

## Unidrive M700 ratings

200/240 Vac ±10%						
Drive	Heavy Duty			Normal Duty		
	Max Continuous Current (A)	Motor Shaft Power (kW)	Motor Shaft Power (hp)	Max Continuous Current (A)	Motor Shaft Power (kW)	Motor Shaft Power (hp)
M700 to M702-03200050A	5	0.75	1	6.6	1.1	1.5
M700 to M702-03200066A	6.6	1.1	1.5	8	1.5	2
M700 to M702-03200080A	8	1.5	2	11	2.2	3
M700 to M702-03200106A	10.6	2.2	3	12.7	3	3
M700 to M702-04200137A	13.7	3	3	18	4	5
M700 to M702-04200185A	18.5	4	5	24	5.5	7.5
M700 to M702-05200250A	25	5.5	7.5	30	7.5	10
M700 to M702-06200330A	33	7.5	10	50	11	15
M700 to M702-06200440A	44	11	15	58	15	20
M700 to M702-07200610A	61	15	20	75	18.5	25
M700 to M702-07200750A	75	18.5	25	94	22	30
M700 to M702-07200830A	83	22	30	117	30	40
M700 to M702-08201160A	116	30	40	149	37	50
M700 to M702-08201320A	132	37	50	180	45	60
M700 to M702-09201760A	176	45	60	216	55	75
M700 to M702-09202190A	219	55	75	266	75	100
M700 to M702-09201760E	176	45	60	216	55	75
M700 to M702-09202190E	219	55	75	266	75	100
M700 to M702-10202830E	283	75	100	325	90	125
M700 to M702-10203000E	300	90	125	360	110	150

380/480 Vac ±10%						
Drive	Heavy Duty			Normal Duty		
	Max Continuous Current (A)	Motor Shaft Power (kW)	Motor Shaft Power (hp)	Max Continuous Current (A)	Motor Shaft Power (kW)	Motor Shaft Power (hp)
M700 to M702-03400025A	2.5	0.75	1	3.4	1.1	1.5
M700 to M702-03400031A	3.1	1.1	1.5	4.5	1.5	2
M700 to M702-03400045A	4.5	1.5	2	6.2	2.2	3
M700 to M702-03400062A	6.2	2.2	3	7.7	3	5
M700 to M702-03400078A	7.8	3	5	10.4	4	5
M700 to M702-03400100A	10	4	5	12.3	5.5	7.5
M700 to M702-04400150A	15	5.5	10	18.5	7.5	10
M700 to M702-04400172A	17.2	7.5	10	24	11	15
M700 to M702-05400270A	27	11	20	30	15	20
M700 to M702-05400300A	30	15	20	31	15	20
M700 to M702-06400350A	35	15	25	38	18.5	25
M700 to M702-06400420A	42	18.5	30	48	22	30
M700 to M702-06400470A	47	22	30	63	30	40
M700 to M702-07400660A	66	30	50	79	37	50
M700 to M702-07400770A	77	37	60	94	45	60
M700 to M702-07401000A	100	45	75	112	55	75
M700 to M702-08401340A	134	55	100	155	75	100
M700 to M702-08401570A	157	75	125	184	90	125
M700 to M702-09402000A	200	90	150	221	110	150
M700 to M702-09402240A	224	110	150	266	132	200
M700 to M702-09402000E	200	90	150	221	110	150
M700 to M702-09402240E	224	110	150	266	132	200
M700 to M702-10402700E	270	132	200	320	160	250
M700 to M702-10403200E	320*	160	250	361	200	300
M700 to M702-11403770E	377	185	300	437	225	350
M700 to M702-11404170E	417*	200	350	487*	250	400
M700 to M702-11404640E	464*	250	400	507*	280	450

\*At 2 kHz switching frequency

500/575 Vac ±10%						
Drive	Heavy Duty			Normal Duty		
	Max Continuous Current (A)	Motor Shaft Power (kW)	Motor Shaft Power (hp)	Max Continuous Current (A)	Motor Shaft Power (kW)	Motor Shaft Power (hp)
M700 to M702-05500030A	3	1.5	2	3.9	2.2	3
M700 to M702-05500040A	4	2.2	3	6.1	4	5
M700 to M702-05500069A	6.9	4	5	10	5.5	7.5
M700 to M702-06500100A	10	5.5	7.5	12	7.5	10
M700 to M702-06500150A	15	7.5	10	17	11	15
M700 to M702-06500190A	19	11	15	22	15	20
M700 to M702-06500230A	23	15	20	27	18.5	25
M700 to M702-06500290A	29	18.5	25	34	22	30
M700 to M702-06500350A	35	22	30	43	30	40
M700 to M702-07500440A	44	30	40	53	45	50
M700 to M702-07500550A	55	37	50	73	55	60
M700 to M702-08500630A	63	45	60	86	75	75
M700 to M702-08500860A	86	55	75	108	90	100
M700 to M702-09501040A	104	75	100	125	110	125
M700 to M702-09501310A	131	90	125	150	110	150
M700 to M702-09501040E	104	75	100	125	110	125
M700 to M702-09501310E	131	90	125	150	110	150
M700 to M702-10501520E	152	110	150	200	130	200
M700 to M702-10501900E	190	132	200	200	150	200
M700 to M702-11502000E	200	150	200	248	185	250
M700 to M702-11502540E	254*	185	250	288*	225	300
M700 to M702-11502850E	285*	225	300	315*	250	350

690 Vac ±10%						
Drive	Heavy Duty			Normal Duty		
	Max Continuous Current (A)	Motor Shaft Power (kW)	Motor Shaft Power (hp)	Max Continuous Current (A)	Motor Shaft Power (kW)	Motor Shaft Power (hp)
M700 to M702-07600190A	19	15	20	23	18.5	25
M700 to M702-07600240A	24	18.5	25	30	22	30
M700 to M702-07600290A	29	22	30	36	30	40
M700 to M702-07600380A	38	30	40	46	37	50
M700 to M702-07600440A	44	37	50	52	45	60
M700 to M702-07600540A	54	45	60	73	55	75
M700 to M702-08600630A	63	55	75	86	75	100
M700 to M702-08600860A	86	75	100	108	90	125
M700 to M702-09601040A	104	90	125	125	110	150
M700 to M702-09601310A	131	110	150	150	132	175
M700 to M702-09601040E	104	90	125	125	110	150
M700 to M702-09601310E	131	110	150	155	132	175
M700 to M702-10601500E	150	132	175	172	160	200
M700 to M702-10601780E	178	160	200	197	185	250
M700 to M702-11602100E	210	185	250	225	200	250
M700 to M702-11602380E	238*	200	250	275*	250	300
M700 to M702-11602630E	263*	250	300	305*	280	400

### Key:

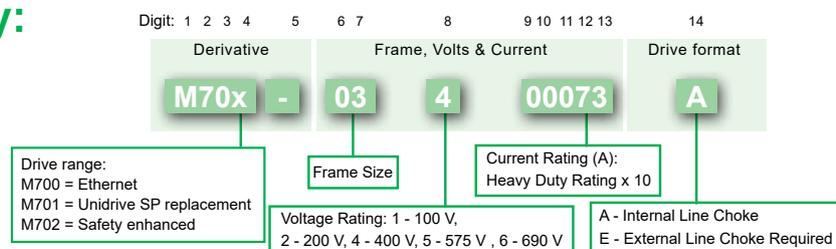

For configurations involving frame size 9 and above refer to the high power brochure

# Unidrive M700 ratings and specifications

## Environmental safety and electrical conformance

- IP20 / NEMA1 / UL TYPE 1\*  
\*UL open class as standard, additional kit needed to achieve Type 1
- IP65 / NEMA4 / UL TYPE 12 rating is achieved on the rear of the drive when through panel mounted
- Frames 9, 10 & 11 achieve IP55 / NEMA4 / UL TYPE 12 rating on the rear of the drive when through panel mounted
- Ambient temperature -20 °C to 40 °C as standard. Up to 55 °C with derating
- Humidity 95 % maximum (non-condensing) at 40 °C
- Altitude: 0 to 3000 m, derate 1 % per 100 m between 1000 m and 3000 m
- Random Vibration: Tested in accordance with IEC 60068-2-64
- Mechanical Shock Tested in accordance with IEC 60068-2-29
- Storage temperature -40 °C to 70 °C
- Electromagnetic Immunity complies with EN 61800-3 and EN 61000-6-2
- With onboard EMC filter, complies with EN 61800-3 (2nd environment)
- EN 61000-6-3 and EN 61000-6-4 with optional footprint EMC filter
- IEC 60146-1-1 supply conditions
- IEC 61800-5-1 (Electrical Safety)
- IEC 61131-2 I/O
- Safe Torque Off, independently assessed by TÜV to IEC 61800-5-2 SIL 3 and EN ISO 13849-1 PLe
- UL 508C (Electrical Safety)

## Optional media and accessories

Description	Order code
SD Card Adaptor	82400000016400
Smartcard (64 kB)	3130-1212

## Internal brake resistor

Frame size	Order code
3	1220-2752
4 & 5	1299-0003

## DC bus paralleling kit

Frame size	Order code
3	3470-0048
4	3470-0061
5	3470-0068
6	3470-0063
6 (connect to frame 3,4 & 5)	3470-0111

## Unidrive M700 feature and specification table

Performance	Current loop update: 62 µs
	Heavy Duty peak rating: 200 % (3 s)
	Maximum output frequency: 550 Hz
	Switching frequency range: 2, 3, 4, 6, 8, 12, 16 kHz (3 kHz default)
	High performance current controllers
Onboard intelligence	Programmable Logic Control (PLC)
	Real-time tasks
	Digital lock control
	Advanced Motion Controller
Onboard comms	Ethernet (2 switched ports), (M701: RS485)
Mechanical attributes	Tile mounting on sizes 3, 4, 5
	Unidrive SP compatible mechanical footprint either as standard or with conversion plates
	Common DC bus connections on sizes 3, 4, 5, 6
Parameter back-up	Ethernet/serial port cloning
	SD card (using SD-Card Adaptor)
	Smartcard reader support
	Electronic motor nameplate parameter storage (HIPERFACE)
Feedback	2 x Encoder input and 1 x Simulated encoder output
Onboard I/O	3 x Analog input, 2 x Analog output, 4 x Digital input, 1 x Digital output, 3 x Bidirectional digital input or output
	(M702: 3 x Digital input, 3 x Digital output and no Analog I/O)
	1 x Relay output
Machine safety	1 x Safe Torque Off (STO) terminal, (M702: 2 x STO)
Power and motor control	Stationary autotune for permanent magnet motors
	Mechanical load resonance compensation
	Wide operating range back-up DC supply
	24 V control back-up
Other	Temperature controlled fan operation with user adjustable speed limit
	User replaceable fan(s)
	Conformal coating
	Standby mode (energy saving)

## Unidrive M operating modes

Operating mode	RFC from cold	RFC from 100 %	Open loop from cold	Open loop from 100 %
Normal duty overload with motor rated current = drive rated current	110 % for 165 s	110 % for 9 s	110 % for 165 s	110 % for 9 s
Heavy duty overload with motor rated current = drive rated current (size 8 and below)	200 % for 28 s	200 % for 3 s	150 % for 60 s	150 % for 7 s
Heavy duty overload with motor rated current = drive rated current (size 9E and 10)	170 % for 42 s	170 % for 5 s	150 % for 60 s	150 % for 7 s

## Through hole IP65 kit

Frame size	Order code
3	3470-0053
4	3470-0056
5	3470-0067
6	3470-0055
7	3470-0079
8	3470-0083

## Through hole IP55 kit

Frame size	Order code
9A	3470-0119
9E & 10D	3470-0105
10 Inverter	3470-0108
10 Rectifier	3470-0106
11E & 11T	3470-0126
11 D Inverter	3470-0130
11 Rectifier	3470-0123

## UL type 1 conduit kit

Frame size	Order code
3 & 4	6521-0071
5	3470-0069
6	3470-0059
7	3470-0080
8 & 9A	3470-0088
9E & 10	3470-0115
11	3470-0136

## Retrofit brackets

To allow Unidrive M drives to be fitted in existing Unidrive SP surface mount installations.

Frame size	Order code
4	3470-0062
5	3470-0066
6	3470-0074
7	3470-0078
8	3470-0087
9A, 9E & 10	3470-0118

## Cable grommet kit

Frame size	Order code
7	3470-0086
8 - Single cable	3470-0089
8 - Dual cable	3470-0090
9A, 9E, 10 & 11	3470-0107

## Tile mount kit

Frame size	Order code
3	3470-0049
4	3470-0060
5	3470-0073

## General kit items

Item	Order code
Keypad blanking cover (10 pieces in pack)	3470-0058
Frame size 3 & 4 power connector split kit	3470-0064
Frame 3 through hole multi-axis kit **	3470-0065
I/O commissioning extender adaptor	3000-0009

\*\* To allow multiple drives to be through hole mounted with no space between them.

## Optional external EMC filters

Unidrive M built-in EMC filter complies with EN 61800-3. External EMC filters are required for compliance with EN 61000-6-4.

Frame size	Voltage	Order code
3	200 V	4200-3230
	400 V	4200-3480
4	200 V	4200-0272
	400 V	4200-0252
5	200 V	4200-0312
	400 V	4200-0402
	575 V	4200-0122
6	200 V	4200-2300
	400 V	4200-4800
	575 V	4200-3690
7	200 V & 400 V	4200-1132
	575 V & 690 V	4200-0672
8	200 V & 400 V	4200-1972
	575 V & 690 V	4200-1662
9A	200 V & 400 V	4200-3021
	575 V & 690 V	4200-1660
9E & 10	200 V & 400 V	4200-4460
	575 V & 690 V	4200-2210
11	400 V	4200-0400
	575 V & 690 V	4200-0690

For a full list of patents and patent applications, visit [www.controltechniques.com/patents](http://www.controltechniques.com/patents).

# Unidrive M frame sizes and ratings

## SINGLE DRIVES



Frame size		3	4	5	6	7	8	
Frame sizes available	M700 → M702	•	•	•	•	•	•	
Dimensions (H x W x D)	mm	365 x 83 x 200	365 x 124 x 200	365 x 143 x 200	365 x 210 x 227	508 x 270 x 280	753 x 310 x 290	
	in	14.4 x 3.3 x 7.9	14.4 x 4.9 x 7.9	14.4 x 5.6 x 7.6	14.4 x 8.3 x 8.9	20 x 10.6 x 11.0	29.7 x 12.2 x 11.4	
Weight	kg (lb)	4.5 (9.9) Max	6.5 (14.3)	7.4 (16.3)	14 (30.9)	28 (61.7)	52 (114.6)	
DC Bus Choke/ AC Line Choke	Internal	•*	•	•	•	•	•	
	External							
Max Continuous Heavy Duty kW Rating	@ 100 V	N/A						
	@ 200 V	0.75 kW - 2.2 kW (1 hp - 3 hp)	3 kW - 4 kW (3 hp - 5 hp)	5.5 kW (7.5 hp)	7.5 kW - 11 kW (10 hp - 15 hp)	15 kW - 22 kW (20 hp - 30 hp)	30 kW - 37 kW (40 hp - 50 hp)	
	@ 400 V	0.75 kW - 4 kW (1 hp - 5 hp)	5.5 kW - 7.5 kW (7.5 hp - 10 hp)	11 kW - 15 kW (15 hp - 20 hp)	15 kW - 22 kW (25 hp - 30 hp)	30 kW - 45 kW (50 hp - 75 hp)	55 kW - 75 kW (100 hp - 125 hp)	
	@ 575 V	N/A		1.5 kW - 4 kW (2 hp - 5 hp)	5.5 kW - 22 kW (7.5 hp - 30 hp)	30 kW - 37 kW (40 hp - 50 hp)	45 kW - 55 kW (60 hp - 75 hp)	
	@ 690 V	N/A				15 kW - 45 kW (20 hp - 60 hp)	55 kW - 75 kW (75 hp - 100 hp)	

\*except 03200050 and 03400062 ratings

Sizes do not include removable mounting brackets



	9A	9E	10E	11E
	•	•	•	•
	1049 x 310 x 290	1010 x 310 x 290	1010 x 310 x 290	1190 x 310 x 312
	41.3 x 12.2 x 11.4	41.3 x 12.2 x 11.4	41.3 x 12.2 x 11.4	46.9 x 12.2 x 12.3
	66.5 (146.6)	46 (101.4)	46 (101.4)	63 (138.9)
	•			
		•	•	•
	45 kW - 55 kW (60 hp - 75 hp)	45 kW - 55 kW (60 hp - 75 hp)	75 kW - 90 kW (100 hp - 125 hp)	N/A
	90 kW - 110 kW (125 hp - 150 hp)	90 kW - 110 kW (125 hp - 150 hp)	132 kW - 160 kW (200 hp - 250 hp)	185 kW - 250 kW (300 hp - 400 hp)
	75 kW - 90 kW (100 hp - 125 hp)	75 kW - 90 kW (100 hp - 125 hp)	110 kW - 132 kW (150 hp - 200 hp)	150 kW - 225 kW (200 hp - 300 hp)
	90 kW - 110 kW (125 hp - 150 hp)	90 kW - 110 kW (125 hp - 150 hp)	132 kW - 160 kW (175 hp - 200 hp)	185 kW - 250 kW (250 hp - 300 hp)

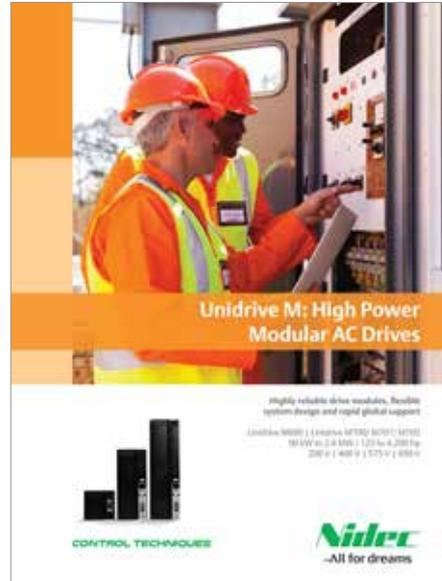

For information on our high power Unidrive M modules (90 kW - 2.8 MW) refer to the Unidrive M high power brochure - available online.



For information on our Unidrive HS70 and HS30 high frequency drives (0-3,000 Hz), refer to the Unidrive HS flyer - available online

**CONTROL TECHNIQUES™**

[www.controltechniques.com](http://www.controltechniques.com)



**SCIGATE AUTOMATION (S) PTE LTD**

No.1 Bukit Batok Street 22 #01-01 Singapore 659592

Tel: (65) 6561 0488

Fax: (65) 6562 0588

Email: [sales@scigate.com.sg](mailto:sales@scigate.com.sg)

Web: [www.scigate.com.sg](http://www.scigate.com.sg)

Business Hours: Monday - Friday 8.30am - 6.15pm

**Nidec**  
All for dreams

Control Techniques Limited. Registered Office: The Gro, Newtown, Powys SY16 3BE. Registered in England and Wales. Company Reg. No. 01236886.